



GRF-3300 Series

RF & SPECTRUM ANALYZER TRAINING SYSTEM

FEATURES

- Designed for Wireless Application Frequency Range
 - Understanding the Applications and Measurements for Using Spectrum Analyzer of Communication Instruments
 - Theory and Hand-on Experiments for Each Chapter Regarding to Topics in the RF System
 - Including 880MHz Digital PLL and 2.4GHz Microstrip Line Filters Circuits
 - Training for the Voice Communication System
-

GW INSTEK
Made to Measure

The Most Integrated and Effective RF Training Solution

The GRF-3300 Series training system is designed for a high frequency range of wireless applications. This superior system is equipped with digital phase locked loop (PLL) and a microstrip line filter (MLF) with a design range from 730MHz up to 960MHz / 2.4 GHz, which is increasingly important in the education field. By using the Wireless Voice Communication system, students can practically complement their education.

The GRF-3300 with the combination of a training syllabus, basic theory, systematic demonstrations and hands-on experiments make it the perfect match for modern RF communication education. The spectrum analyzer used in the training system is not only capable of experimenting with measurement testing, but is also a standard industrial instrument itself, making it practical for students to adapt in the occupational field.

The GRF-3300 Series assists students in learning the operation principles of an RF system, understanding spectrum analysis and recognizing its application for wireless communication systems. The GRF-3300 Series includes 22 modules that cover a broad range of RF communication topics. Each module has relevant, well presented and structured experimental exercises. Altogether, there are more than 50 experiments within the training program. The GRF-3300 syllabus is flexible in both duration and content. The syllabus can be tailored for one or two semesters without sacrificing the core topics.

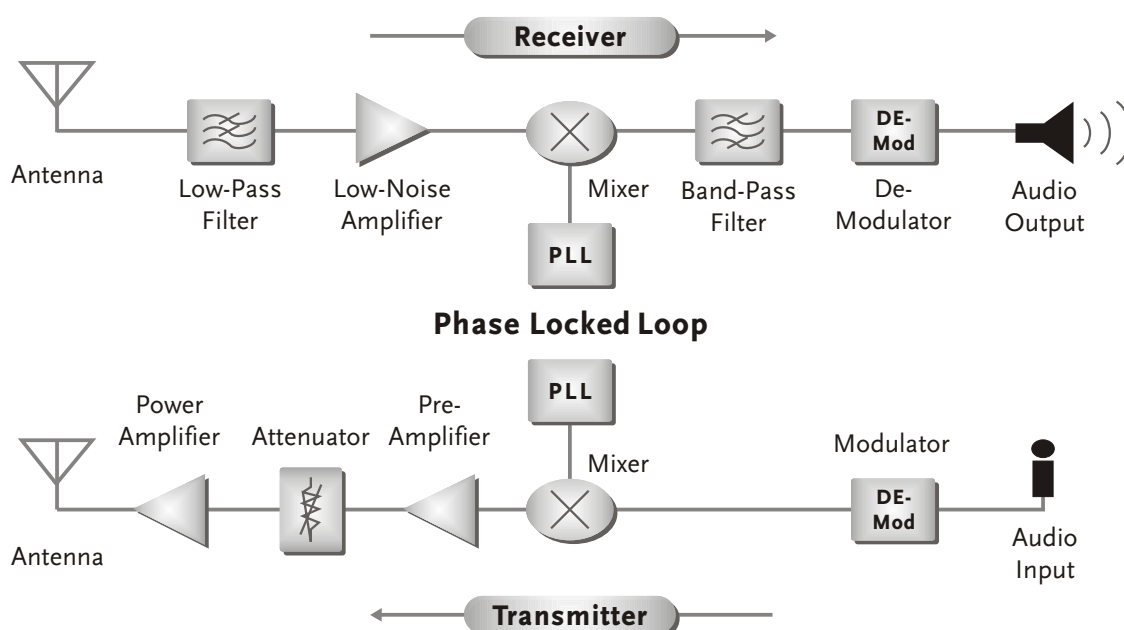

PANEL INTRODUCTION



- | | |
|------------------------|----------------------------|
| 1. Antenna | 7. Mixer |
| 2. Attenuator | 8. Phase-Locked Loop |
| 3. Low Noise Amplifier | 9. Audio Processor |
| 4. Preamplifier | 10. Modulation |
| 5. Power Amplifier | 11. Demodulation |
| 6. Filter | 12. Microstrip Line Filter |

FEATURES

- Designed for Wireless Frequency Range Applications
- Includes a 880MHz Digital Phase-Locked Loop and 2.4GHz Microstrip Line Filter Circuits
- Training for the Voice Communication System
- Demonstrates the Applications and Measurements for Using Spectrum Analyzers in Communication Instruments
- Instructional Theory and Hands-on Experiments for Each Chapter Covering Topics in RF Systems
- Designed for the Application of the RF Transmitter and Receiver Systems
- Specific RF Circuit Characteristics & PCB Layout on Each Module
- Training System Covering 22 Modules, and Over 50 Experiments

GRF-3300S



GRF-3300K



A. Digital Phase-Locked Loop

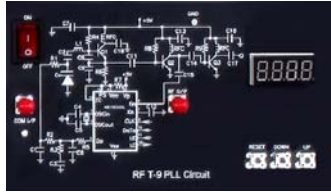

PLL Circuit in Transmitter

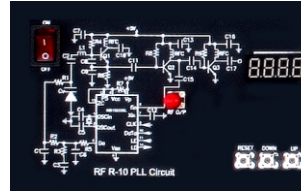

PLL Circuit in Receiver

The 880MHz Phase-Locked Loop (PLL) is one of unique features of the GRF-3300. Digital PLLs are one of the key components in building many communication products for the wireless technology industry; for example, cell phones, wireless adapters, and Bluetooth devices. It ensures high frequency signals can be performed with high stability. However, most of the training systems available in the market are only capable of providing

frequencies below 50MHz for PLL experimental circuits. In the GRF-3300 series, Digital PLL technology for the frequency synthesizer is intergraded into both the transmitter (frequency of $880 \pm 80\text{MHz}$) and receiver (frequency of $809.3 \pm 80\text{MHz}$). The frequency resolution of up to 1MHz enables a bandwidth of 80MHz for transmitting/receiving with more than 80 usable channels.

B. Special Circuit Feature Microstrip Line Filter

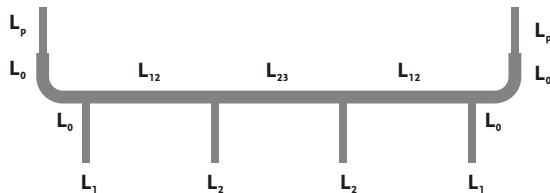

Microstrip Line High Pass Filter Circuit

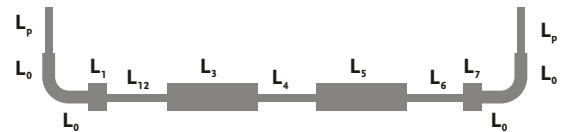

Microstrip Line Low Pass Filter Circuit

Microstrip line is a tough subject for many students because its behavior is more specific and complex than general electronic theory. It is also difficult to implement. In the GRF-3300, the microstrip line theory is first introduced and then implemented with filters. On the GRF-3300 the microstrip is implemented with

practical line filters and built with FR4, one of the most common PCB materials. This approach to microstrip design provides a practical, real-world and easy to comprehend platform for students.

C. Voice Communication System Training

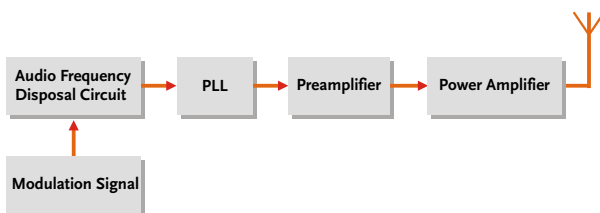

Voice Transmitter

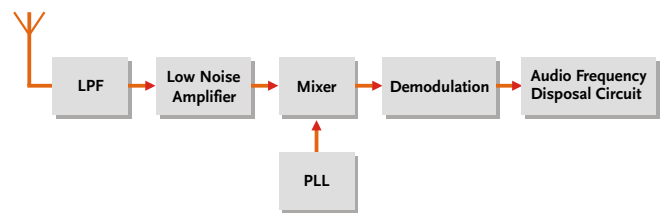

Voice Receiver

Both the transmitting and receiving systems can be integrated by connecting the microphone as a voice input transmitter and using a speaker as a voice output receiver. This makes the system a real wireless voice communicating experience for students. To the further, most of the students may gain more

comprehension from systemizing the modules of transmitter and receiver i.e., they can learn how RF circuits work clearly and concisely. We believe through this modular training of step-by-step approach is the fastest way to develop a student to into a professional RF engineer.

D. Getting Familiar with RF Instruments: Spectrum Analyzer

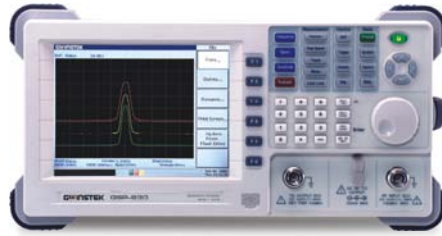

GSP-830 3GHz Spectrum Analyzer



RLB-001 Return Loss Bridge

The most common instrument for RF signal measurement is the spectrum analyzer. In the lab, the GRF-3300 is used in conjunction with a spectrum analyzer to get students familiar with the practical application of spectrum analyzers in the occupational industry. Likewise, a spectrum analyzer can work as a networking analyzer to measure the returning loss

value by incorporating it with a Tracking Generator (TG) and RLB-001 Return Loss Bridge. This efficiently helps to boost the measuring capability and save on expenditures without acquiring other test equipment.

E. Complete Learning Experience

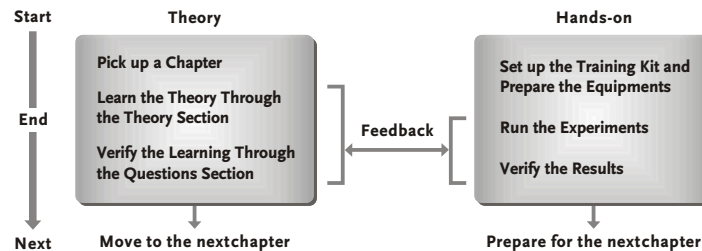

Studying Flow

The GRF-3300 manual is comprised of two parts: the teachers' book and the students' book. In each chapter the included experiments contain theoretical explanations, circuit structures, experiment contents, illustrations, and a discussion of each experiment result. Depending on the instructional requirements, the workflow of the manual can be modified to fit according to

practical needs. Any chapter can be used separately for instruction without the completion of previous chapters. All students are guided step by step through the experiments with clear and concise instructions. All of the experimental results and solutions are illustrated in the teachers' book.

F. Designing for Systemization and Modularization



GRF-3300S

GRF-3300K

The GRF-3300S includes all the RF circuit modules in two cases: transmitter and receiver. All circuit modules are preassembled, integrated and ready to go. The central power module with a general AC socket provides all the internal power required. This model is convenient for portable applications and easy demonstrations, allowing students to concentrate on learning, without the hassle of preparing and configuring. The GRF-3300K kit separates the circuit modules into small blocks, enabling flexible placement and sharing one training system with multiple students who run different experiments simultaneously.

G. Observable PCB Layout

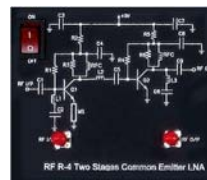

Front Side - Circuit Structure

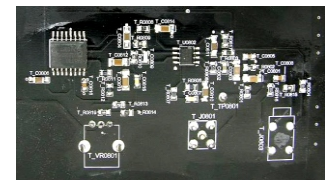

Back Side - PCB Layout

In the GRF-3300, each module's circuitry and layout are clearly printed upon the PCB, making it visible to students for a better learning experience.

TRAINING CONTENTS

Element	Theory	Experiment	Related Application
The Fundamentals	Impedance matching network: L-type, π -type, T-type Smith chart: theory and practical examples	Theory explaining	RF Component Test
Antenna	Antenna parameter, antenna structure, antenna type	Frequency response	Antenna Design
Attenuator	Attenuator parameter, attenuator type, attenuator design	Attenuation characteristics	When the Signal is Too Big
Low Noise Amplifier	LNA parameter, 1dB compression point, LNA structure	Input and output return loss, amplifier gain, 1dB compression point	Small Signal Enlarged
Preamplifier	Preamplifier type, preamplifier structure	Input and output return loss, amplifier gain, 1dB compression point	Small Signal Enlarged
Power Amplifier	Power amplifier frequency characteristics, bias circuit, power amplifier parameter, power amplifier structure	Gain flatness, 1dB compression point, fundamentals to harmonics ratio	Power Enlarge
Filter	Filter parameter, filter structure : Butterworth, Chebyshev	Input/output return loss, insertion loss	EMI Filter Design
Mixer	Mixer structure, mixer parameter, mixer type	Conversion gain, 1dB compression point, isolation	TV Tuner
Phase-Locked Loop	PLL structure, frequency synthesizer, PLL controller, loop filter, design a PLL	Frequency response/modulation	Signal Generator
Audio Processor	Audio compression/decompression circuit	Pre-emphasis, compression characteristics, expander and de-emphasis, decompression characteristics	Wireless Microphone
Modulation	Design and implement a modulation circuit	Frequency modulation	Remote Controller
Demodulation	Design and implement an FM intermediate frequency demodulation circuit	IF modulation, RSSI output	Broadcasting
Transmitter	Transmitter parameter, transmitter structure	Transmission spectrum	Radio Set
Receiver	Receiver parameter, receiver structure	Receiving signal spectrum, demodulation waveform	Radio Set
Voice Demo	Combine with transmitter & receiver circuits	Voice communication system	VoIP
Microstrip Line Filter	Transmission line basics, stepped-impedance LPF, coupled line BPF, optimized HPF	Insertion loss	RFID

POWER SOURCE

AC 110V or 220V, 50/60Hz

DIMENSIONS & WEIGHT

GRF-3300S 428(W) x 90(H) x 303(D) mm for Transmitter & Receiver Box, Approx. 8.4kg

GRF-3300K 560(W) x 170(H) x 530(D) mm, Approx. 7kg

Specifications subject to change without notice.

RF-3300GD2BH

ORDERING INFORMATION

GRF-3300S Package Including Spectrum Analyzer GSP-830 + Tracking Generator(TG), RF Training System GRF-3300S

GRF-3300K Package Including Spectrum Analyzer GSP-830 + Tracking Generator(TG), RF Training Kit Sets GRF-3300K

GRF-3300S(*) RF Training System, Two Systems (Transmitter and Receiver)

GRF-3300K(*) RF Training Kit Sets, 22 Modules (12 for Receiver and 10 for Transmitter systems)

(*)All GRF-3300S/K experiments are based upon GSP-830, we can't guarantee the result almost has its similarity by using other spectrum analyzers of their kinds.

ACCESSORIES :

Teacher book & Student book

50 Ω Terminator

AC Power cord (only for GRF-3300S) x 2

Antenna x 2

DC Power cable (red, black) (only for GRF-3300K) x 10

Microphone

N-SMA Adaptor x 3

Return loss bridge

RF Cable, 10cm x 6

RF Cable, 20cm x 6

RF Cable, 75cm x 3

SMA-SMA Connector

ACCESSORIES

N-SMA Adaptor

SMA(I/F) ~ N(P/M)



RF Cable Assembly

SMA(P/M), (10,20,75cm)



Microphone



RLB-001 Return Loss Bridge 50

10MHz ~ 1GHz



Terminator



SMA-SMA Connector



Antenna



DC Power Cable

(Red, Black)



Global Headquarters

GOOD WILL INSTRUMENT CO., LTD.

No. 7-1, Jhongsing Road, Tucheng City, Taipei County 236, Taiwan

T +886-2-2268-0389 F +886-2-2268-0639

E-mail: marketing@goodwill.com.tw

China Subsidiary

INSTEK ELECTRONIC (SHANGHAI) CO., LTD.

4F, of NO.2 Building, No.889 Yishan Road, Shanghai China

T +86-21-6485-3399 F +86-21-5450-0789

E-mail: marketing@instek.com.cn

Malaysia Subsidiary

GOOD WILL INSTRUMENT (M) SDN. BHD.

27, Persiaran Mahsuri 1/1, Sunway Tunas,

11900 Bayan Lepas, Penang, Malaysia.

T +604-6309988 F +604-6309989

E-mail: sales@goodwill.com.my

U.S.A. Subsidiary

INSTEK AMERICA CORP.

3661 Walnut Avenue Chino, CA 91710, U.S.A.

T +1-909-5918358 F +1-909-5912280

E-mail: sales@instek.com

Japan Subsidiary

INSTEK JAPAN CORPORATION

4F, Prosper Bldg, 1-3-3 Iwamoto-Cho Chiyoda-Ku,

Tokyo 101-0032 Japan

T +81-3-5823-5656 F +81-3-5823-5655

E-mail: info@instek.co.jp

Korea Subsidiary

GOOD WILL INSTRUMENT KOREA CO., LTD.

Room No.805, Ace Hightech-City B/D 1Dong,

Mullae-Dong 3Ga 55-20, Yeongduengpo-Gu, Seoul, Korea

T +82 2 3439 2205 F +82 2 3439 2207

E-mail: gwinstek@gwinstek.co.kr

GW INSTEK

www.instek.com